

# star

hydraulics ltd

SERVO TECHNOLOGY  
AND RESEARCH

## Model 200 Servovalve



- Nominal flows rates 1 to 7 l/min @ 70 bar
- Sapphire Technology
- Miniature design
- High-Response characteristics
- Internal pilot supply

**econ**  
FLUID POWER

上海益控精密机械有限公司

**Shanghai Econ Precision Machinery Co.,Ltd.**

上海市浦东新区东方路738号裕安大厦9楼916室, 200122

Tel: 021-58205117 Fax: 021-58315902

Web: [www.econpm.cn](http://www.econpm.cn) E-mail: [info@econpm.cn](mailto:info@econpm.cn)

<b>Nominal flow ratings</b>	2, 4, 7 l/min at 70 bar p For other flow ratings contact factory
<b>Hysteresis</b>	< 3% without dither
<b>Threshold</b>	< 0.5% without dither
<b>Null bias</b>	< 2%
<b>Null shift</b>	< 2%
with 40°C temp change	< 2%
with 70 bar supply pressure change	< 2%
with return pressure 0 to 35 bar	< 2%
<b>Pressure gain</b>	< 1% rated input signal for 60% of supply pressure
<b>Seal materials available</b>	FPM, NBR, EPDM
<b>Operating temperature range</b>	-30 °C to 130 °C
<b>Proof pressure</b>	
at pressure port	150% max supply pressure
at return port	100% max supply pressure
<b>Burst pressure</b>	
return port open	250% max supply pressure
<b>External leakage</b>	zero
<b>Degree of protection</b>	IP 65 (BS EN 60529 : 1992)
<b>Weight</b>	230 g
<b>Mounting position</b>	Any, fixed or movable

<b>Supply filtration</b>	
minimum	$\geq 10$ 75 (10 micron abs)
recommended	$\geq 5$ = 200 (5 micron abs)
<b>Fluid cleanliness level</b>	
minimum	ISO 4406 - 16/13    NAS 1638 - class 7
recommended	ISO 4406 - 13/10    NAS 1638 - class 4
<b>Supply pressure</b>	
min. to effect spool movement	3.5 bar
minimum recommended	15 bar
maximum continuous	210 bar (FPM & EPDM)    315 bar (NBR)
<b>Viscosity</b>	VG 10 to 100 ISO 3448
<b>Fluid type</b>	Petroleum based mineral oils For operation with other media contact factory

### Calculating output flow

The output flow for a given pressure drop can be calculated using the following:

$$q = q_N \sqrt{\frac{\rho_N}{\rho_V}}$$

Where:

$q$  = Output flow [l/min]

$q_N$  = Rated flow [l/min]

$\rho_N$  = Valve pressure drop [bar]

$\rho_V$  = Rated valve pressure drop [bar]

Output flow versus load pressure difference

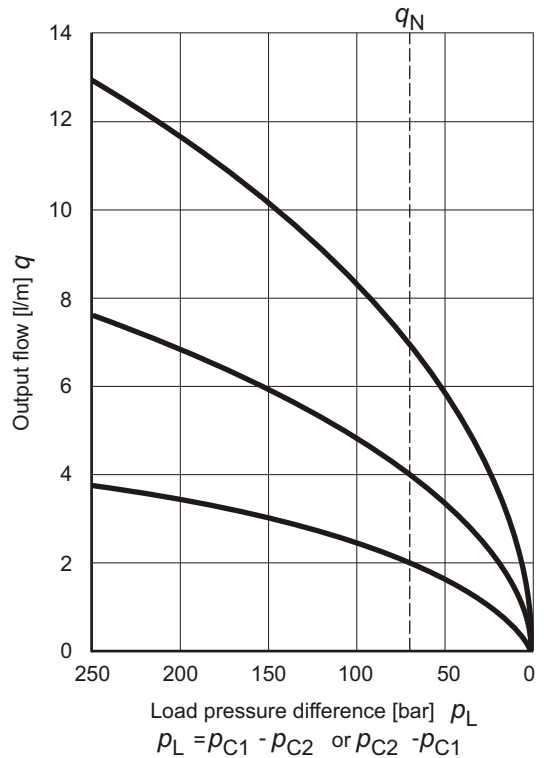

### Internal leakage

This comprises of both pilot stage flow (tare leakage) and the second stage null leakage, typical values for this size of valve would be:

Rated flow	Internal leakage at 140 bar
2 l/min	< 0.3 l/min
4 l/min	< 0.3 l/min
7 l/min	< 0.5 l/min

Output flow versus input signal at constant valve pressure drop

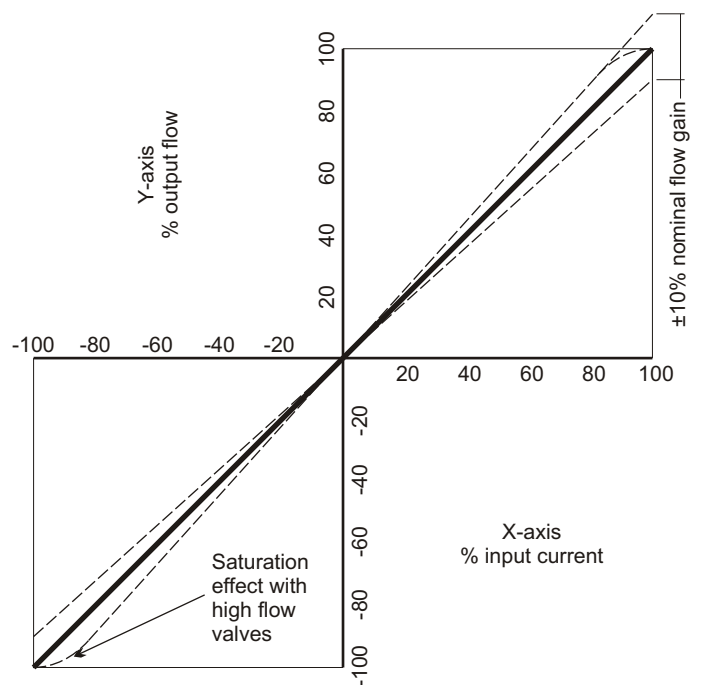

The flow tolerance for standard servovalves is  $\pm 10\%$  of the nominal rated flow at  $\pm 100\%$  input signal.

The rated flow is quoted at 70 bar  $p$  and 100% rated input signal.

**Coil schematics**

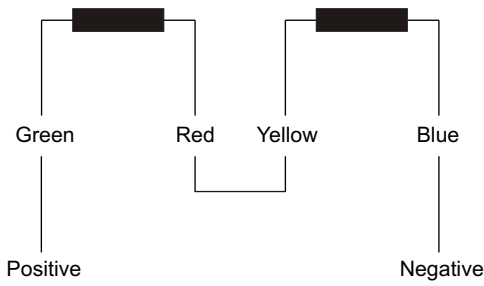

**Series connection**

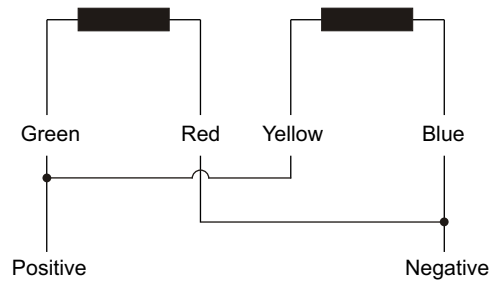

**Parallel connection**

**Output flow polarity**

Flow in the direction of P→C2, C1→R will occur with the pilot stage coils configured as above.

**Coil options**

Coil specification		Series connection		Parallel connection	
Rated signal [mA]	Resistance per coil [ Ω ]	Input current [mA]	Effective resistance [ Ω ]	Input current [mA]	Effective resistance [ Ω ]
10	1000	5	2000	10	500
15	200	7.5	400	15	100
20	1200	10	2400	20	600
30	300	15	600	30	150
30	800	15	1600	30	400
40	80	20	160	40	40
60	40	30	80	60	20
80	22	40	44	80	11
100	27	50	54	100	13.5
200	22	100	44	200	11

**Electrical connection**

The standard connection is by colour coded flying leads. Other options available contact factory for more details.

# Transient Response

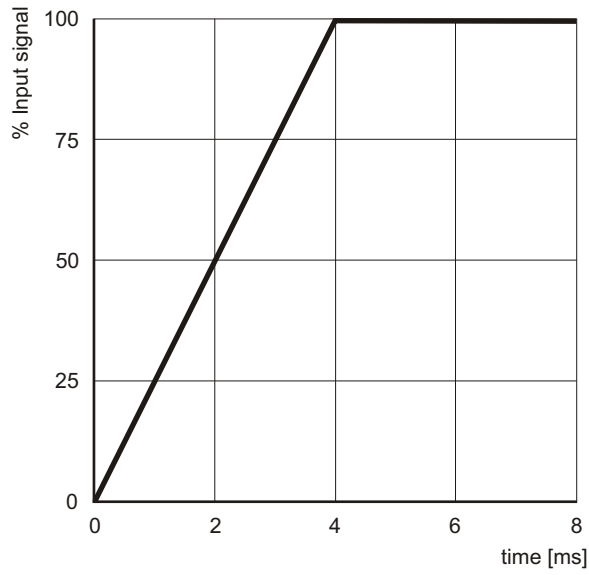

Rated flow = 7 l/min  
Supply pressure = 210 bar

# Frequency Response

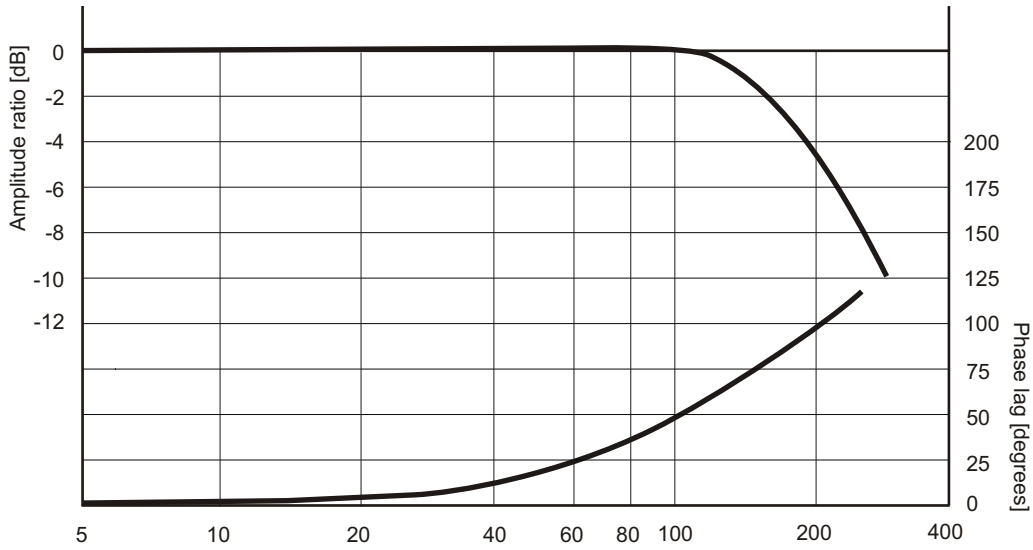

Input signal = 25%  
Rated flow = 7 l/min  
Supply pressure = 210 bar

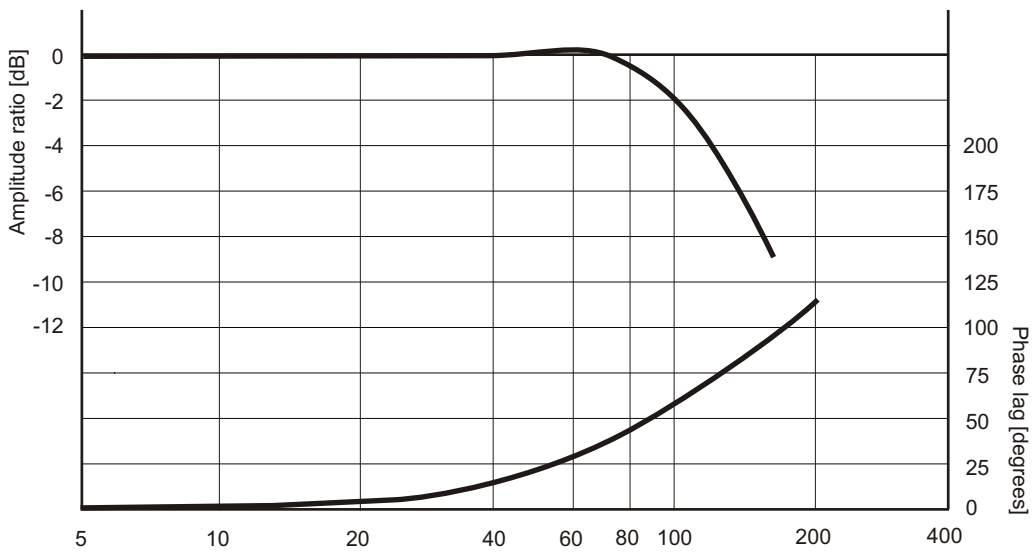

Input signal = 100%  
Rated flow = 7 l/min  
Supply pressure = 210 bar

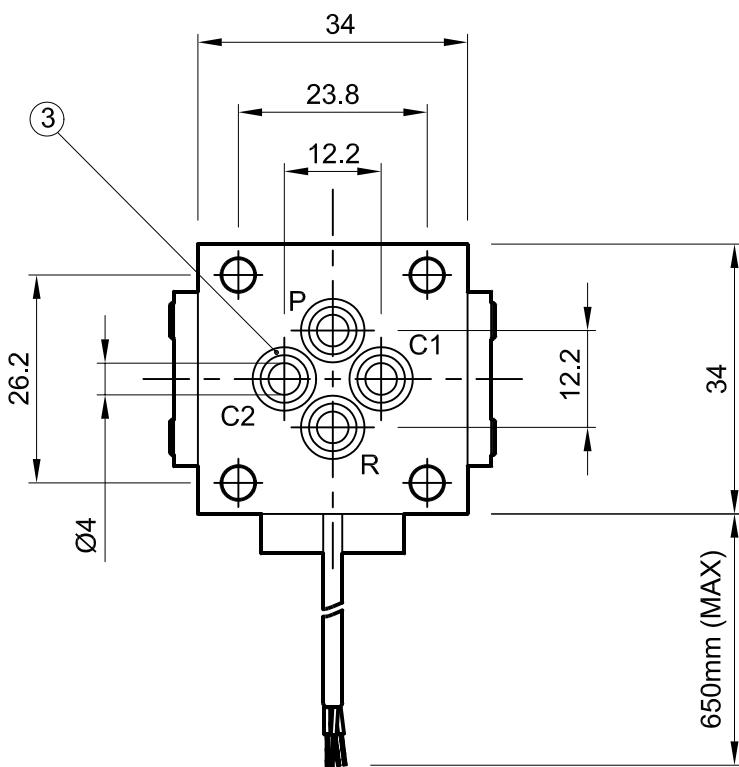
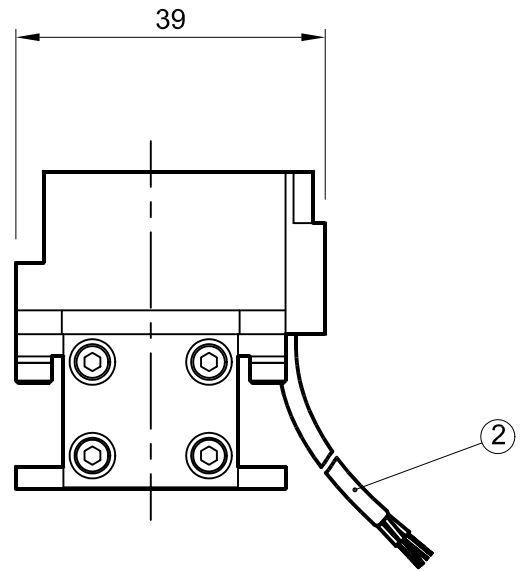
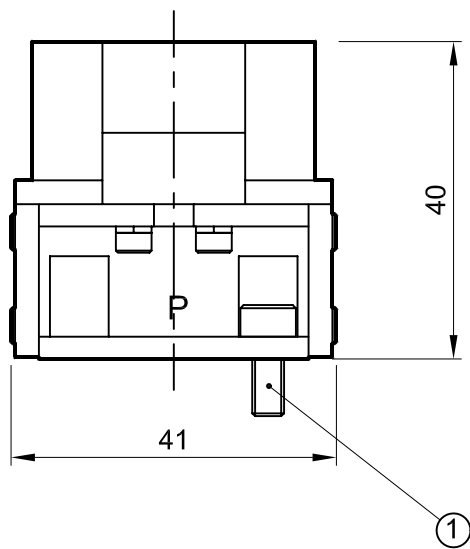

1. Suggested mounting bolts M4 x 10 long high tensile steel socket head cap screws.
2. Colour coded flying lead available at 180° to position shown (advise desired position at time of order).
3. Base O-Rings: 6 I/D x 1 section (4 pcs).

## Installation Details Model 200

Dimensions in millimeters  
3rd angle projection

Filename  
ID200-2Q02-En

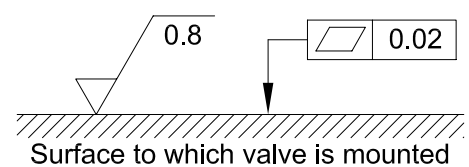

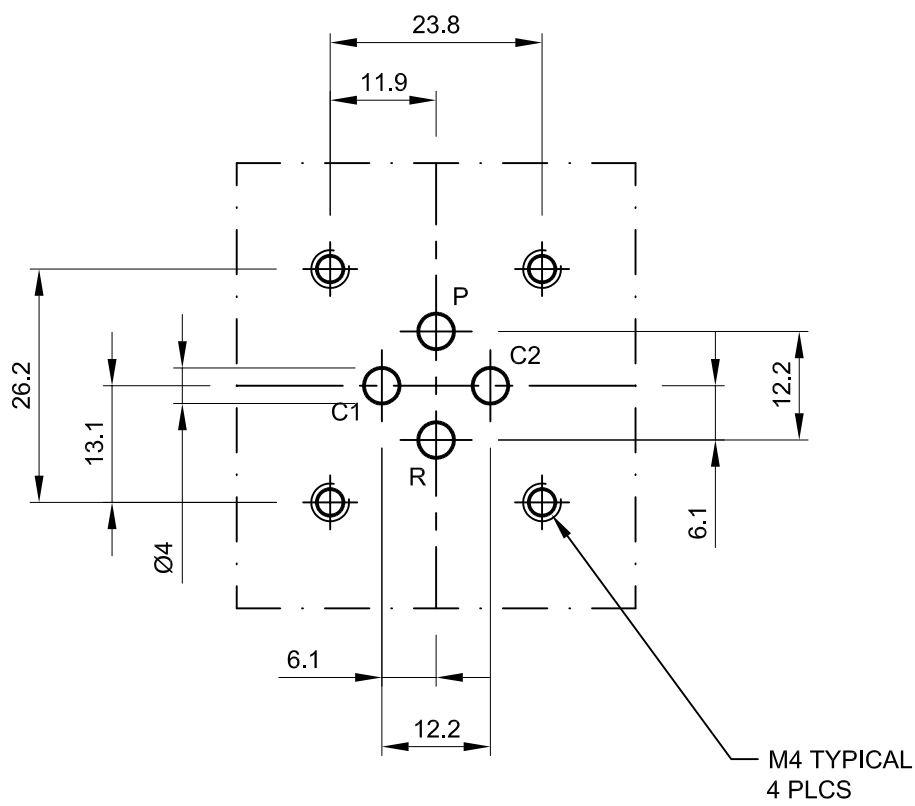

## Manifold Dimensions Model 200

Dimensions in millimeters  
3rd angle projection

Filename  
MD200-1Q03-En

